

PROFILS EPIC

130 000 combinaisons possibles.

Vous recherchez un luminaire suspendu moderne ou un éclairage de magasin performant ? Ici, vous obtenez les deux ! Laissez-vous surprendre par le profil LED EPIC. Avec plus de 130 000 combinaisons possibles, le profil LED EPIC offre toujours la solution d'éclairage optimale. Grâce à sa structure modulaire, vous pouvez définir vos priorités individuellement.



BASE PARMIS 130000 SOLUTIONS PROFIL EPIC

Avec plus de 130000 combinaisons possibles, le profil LED EPIC offre toujours la solution d'éclairage optimale.
 Epic permet l'installation de LED jusqu'à 22mm de largeur et de 48W/m de puissance maximum.

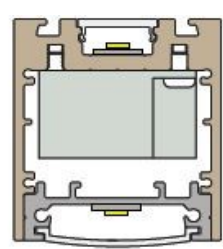
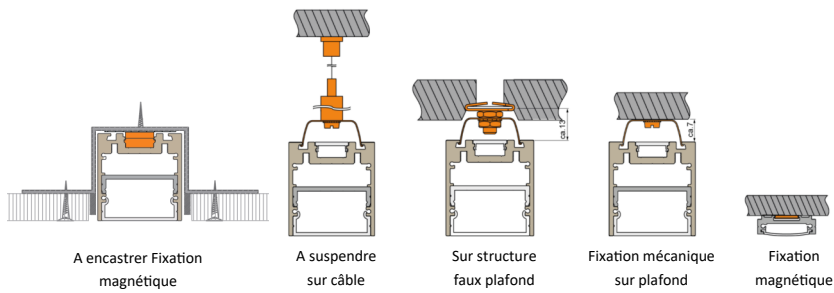
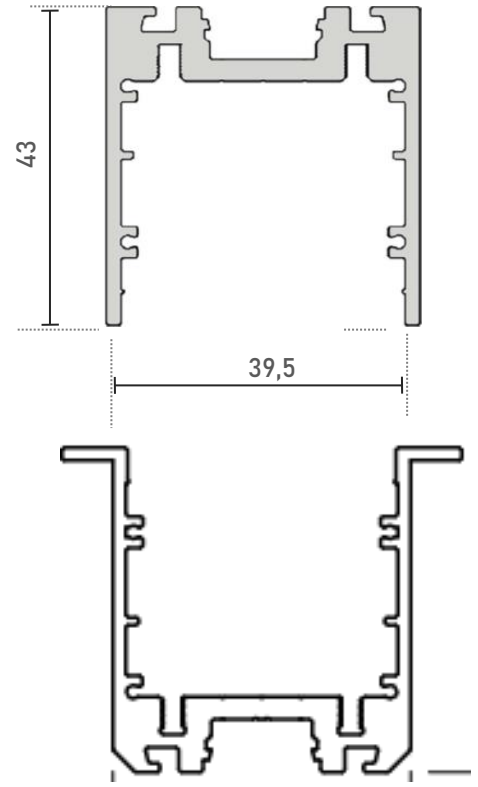

EPIC I
P4043-1 page 63

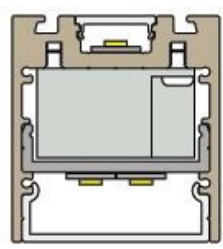

EPIC II
P4043-2 page 63

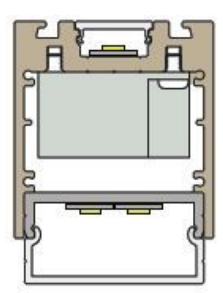

EPIC III
P4043-3 page 64

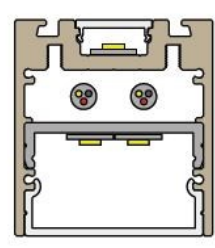

EPIC IV
P4043-4 page 64

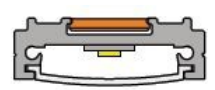
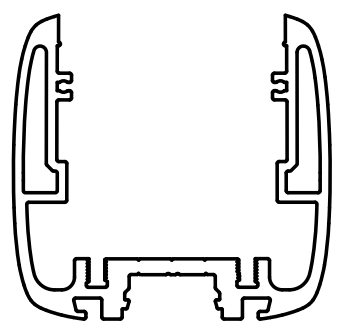

EPIC VII
P1136-7 page 66

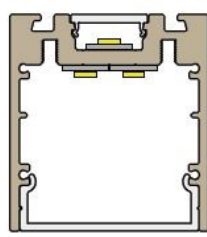

EPIC V
P4043-5 page 65

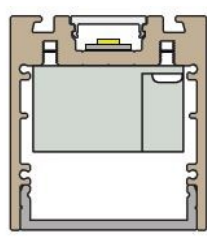

EPIC VI
p4043-6 page 65

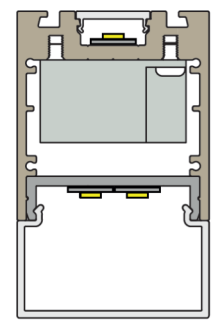

EPIC VIII
P4043-8 page 66

P4043-1 Profil EPIC-I

Puissance maximum 48W/m



Référence	Désignation
500-561-0#	Profile aluminum EPIC, anodisé
500-561-1#	Profile aluminum EPIC, blanc RAL 9010
500-561-2#	Profile aluminum EPIC, noir RAL 9005
500-561-3#	Profile aluminum EPIC, autre RAL sur demande

Profile Ultimate support LED

Référence	Désignation
500-569-0#	Profile aluminum, anodisé
500-569-1#	Profile aluminum, blanc RAL 9010
500-569-2#	Profile aluminum, noir RAL 9005
500-569-3#	Profile aluminum, autre RAL sur demande

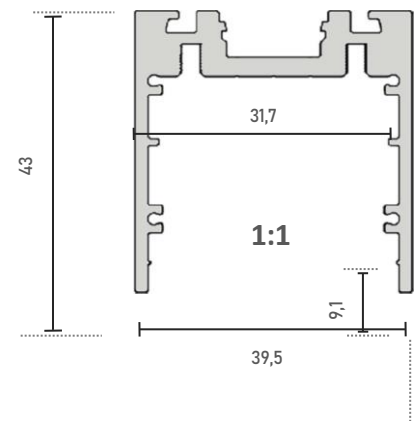
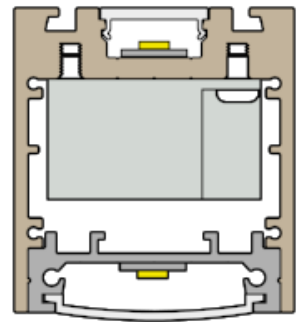

Diffuseurs

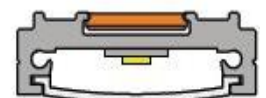
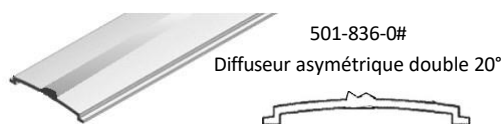
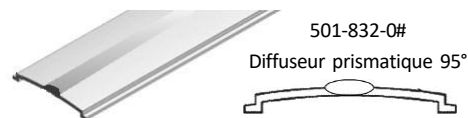
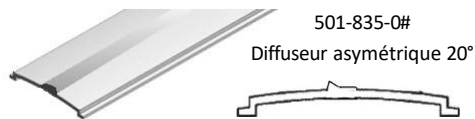
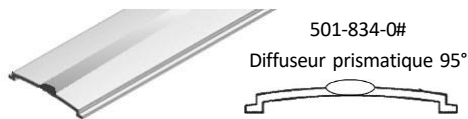
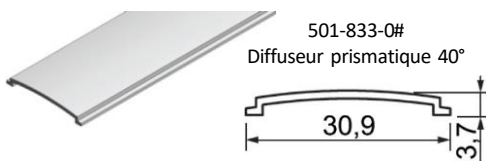

550-569-xx
Profilé support LED



= 1 longueur de 1,00 m | # = 2 longueur de 2,01 m | # = 3 longueur de 3,02 m
*Frais de transport à prévoir pour longueur supérieur à 2,01 m

Toutes les informations, les images et les fichiers sur cette page sont données à titre indicatif et peuvent subir des modifications sans préavis

ACCESSOIRES EPIC I



501-841-5#000
Diffuseur cristallisé partie haute



501-841-1#000
Diffuseur transparent partie haute

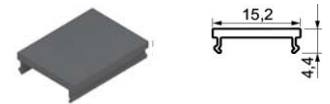

501-841-8#000
Diffuseur opale satiné partie haute



600-340-xx
Support suspension inclus
câble de suspension 3,00m

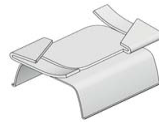

600-340-03
fixation pour plafond
dalles suspendu



600-340-xx
Fixation pour fixation en sailli

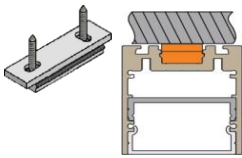

550-575-86 / 261-506-99
Kit de fixation magnétique HR



550-490-86
kit de fixation



550-875-86
Kit de fixation magnétique

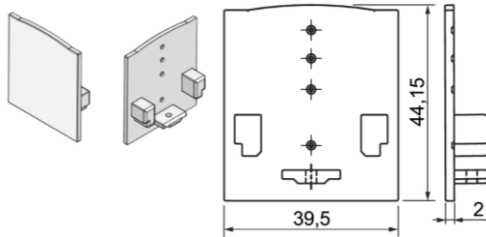

550-568-xx
Embout de finition Epic I

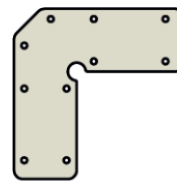

550-564-92
Raccordement d'angle

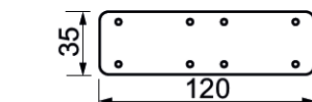
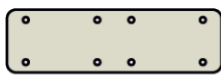
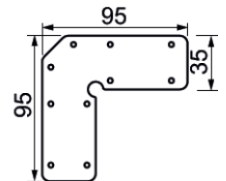

550-565-92
Raccordement droit intérieur

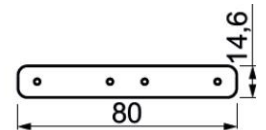

550-576-92
raccordement droit partie haute

Alimentation DALI Dimmable



552-650-01 Dimension 346 x 32 x 22 200-240Vac/24Vdc 50W
552-650-01 Dimension 346 x 32 x 22 200-240Vac/24Vdc 80W

Alimentation non Dimmable



552-617-50 Dimension 251 x 30 x 17 200-240Vac/24Vdc 30W
552-610-50 Dimension 346 x 30 x 16 200-240Vac/24Vdc 45W
552-603-50 Dimension 305 x 30 x 16,7 200-240Vac/24Vdc 75W
552-618-50 Dimension 320 x 30 x 19,5 200-240Vac/24Vdc 100W

= 1 longueur de 1,00 m | # = 2 longueur de 2,01 m | # = 3 longueur de 3,02 m
*Frais de transport à prévoir pour longueur supérieure à 2,01 m

P4043-2 Profil EPIC-II

Puissance maximum 48W/m



Référence	Désignation
500-561-0#	Profile aluminum EPIC, anodisé
500-561-1#	Profile aluminum EPIC, blanc RAL 9010
500-561-2#	Profile aluminum EPIC, noir RAL 9005
500-561-3#	Profile aluminum EPIC, autre RAL sur demande

Profil Epic Light support LED

Référence	Désignation
500-562-0#	Profile aluminum, anodisé
500-562-1#	Profile aluminum, blanc RAL 9010
500-562-2#	Profile aluminum, noir RAL 9005
500-562-3#	Profile aluminum, autre RAL sur demande

Diffuseur

Référence	Désignation
501-563-5#	Diffuseur bas blanc opale 67%
501-563-8#	Diffuseur bas noir opale

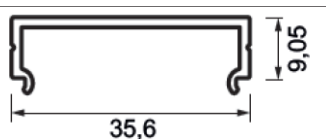
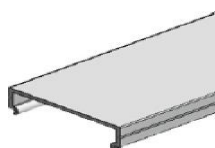

501-563-5#
Diffuseur PMMA, opale

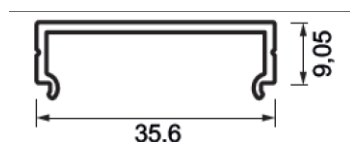

501-563-8#000
Diffuseur PMMA, opale Noir

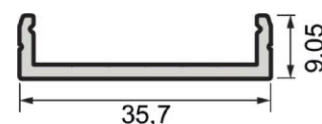
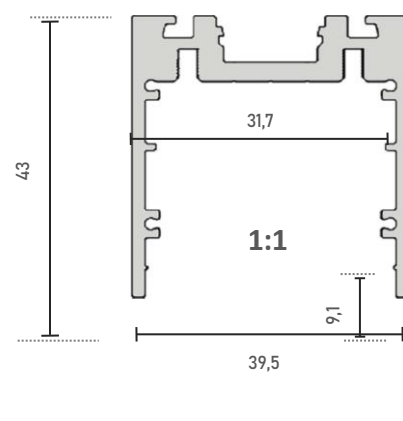
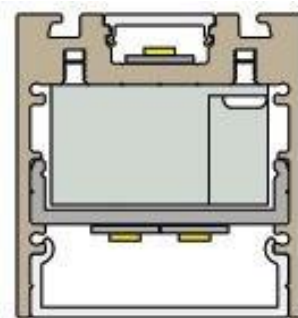

= 1 longueur de 1,00 m | # = 2 longueur de 2,01 m | # = 3 longueur de 3,02 m

*Frais de transport à prévoir pour longueur supérieure à 2,01 m

Toutes les informations, les images et les fichiers sur cette page sont données à titre indicatif et peuvent subir des modifications sans préavis

ACCESSOIRES EPIC II



501-841-5#000
Diffuseur cristallisé partie haute



501-841-1#000
Diffuseur transparent partie haute



501-841-8#000
Diffuseur opale satiné partie haute



600-340-xx
Support suspension inclus
câble de suspension 3,00m

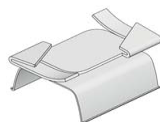

600-340-03
fixation pour plafond
dalles suspendu



600-340-xx
Fixation pour fixation en sailli

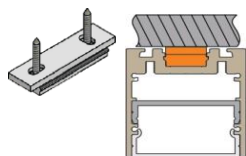

550-575-86 / 261-506-99
Kit de fixation magnétique HR



550-490-86
kit de fixation



550-875-86
Kit de fixation magnétique

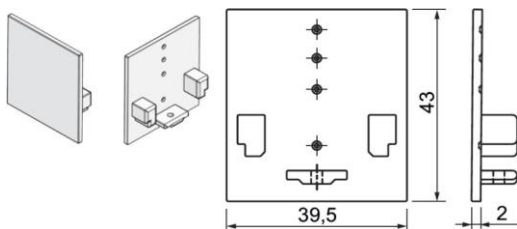

550-566-zz
Embout de finition Epic II

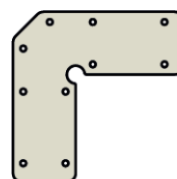

550-564-92
Raccordement d'angle

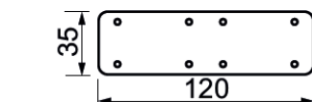
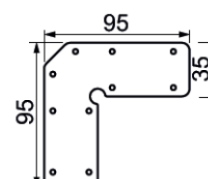

550-565-92
Raccordement droit intérieur

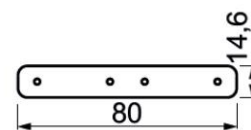

550-576-92
raccordement droit partie haute

Alimentation DALI Dimmable



552-650-01 Dimension 346 x 32 x 22 200-240Vac/24Vdc 50W
552-650-01 Dimension 346 x 32 x 22 200-240Vac/24Vdc 80W

Alimentation non Dimmable



552-617-50 Dimension 251 x 30 x 17 200-240Vac/24Vdc 30W
552-610-50 Dimension 346 x 30 x 16 200-240Vac/24Vdc 45W
552-603-50 Dimension 305 x 30 x 16,7 200-240Vac/24Vdc 75W
552-618-50 Dimension 320 x 30 x 19,5 200-240Vac/24Vdc 100W

= 1 longueur de 1,00 m | # = 2 longueur de 2,01 m | # = 3 longueur de 3,02 m

*Frais de transport à prévoir pour longueur supérieure à 2,01 m

Toutes les informations, les images et les fichiers sur cette page sont données à titre indicatif et peuvent subir des modifications sans préavis

P4043-3 Profil EPIC

Puissance maximum 48W/m



Référence	Désignation
500-561-0#000	Profile aluminum EPIC, anodisé
500-561-1#000	Profile aluminum EPIC, blanc RAL 9010
500-561-2#000	Profile aluminum EPIC, noir RAL 9005
500-561-3#000	Profile aluminum EPIC, autre RAL sur demande

Profil Epic Light support LED

Référence	Désignation
500-562-0#000	Profile aluminum, anodisé
500-562-1#000	Profile aluminum, blanc RAL 9010
500-562-2#000	Profile aluminum, noir RAL 9005
500-562-3#000	Profile aluminum, autre RAL sur demande

Diffuseur

Référence	Désignation
501-563-5#	Diffuseur bas blanc opale 67%
501-372-5#	Diffuseur haut blanc opale 62%
501-563-8#	Diffuseur bas noir opale

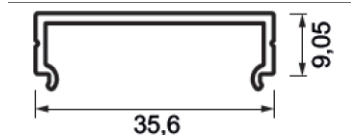
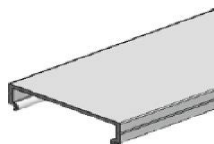

501-563-5#000
Diffuseur PMMA, opale

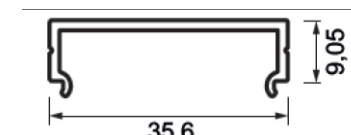

501-563-8#000
Diffuseur PMMA, opale Noir

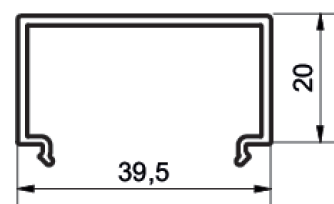
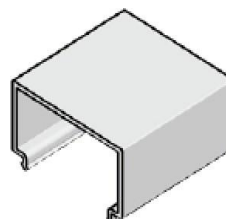

501-572-5#000
Diffuseur haut, PMMA, opale

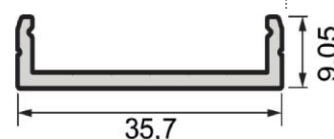
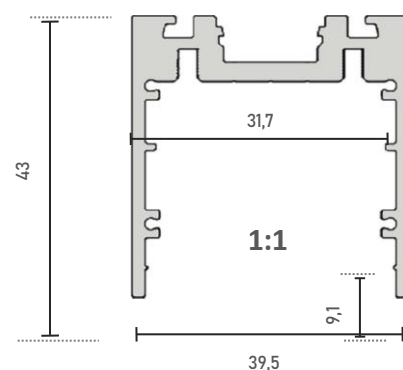
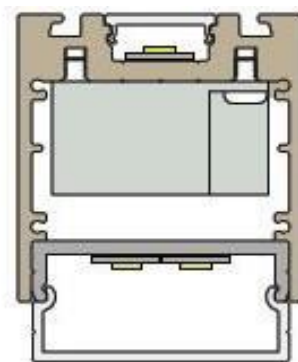

= 1 longueur de 1,00 m | # = 2 longueur de 2,01 m | # = 3 longueur de 3,02 m

*Frais de transport à prévoir pour longueur supérieure à 2,01 m

Toutes les informations, les images et les fichiers sur cette page sont données à titre indicatif et peuvent subir des modifications sans préavis

ACCESSOIRES EPIC III



501-841-5#000
Diffuseur cristallisé partie haute



501-841-1#000
Diffuseur transparent partie haute



501-841-8#000
Diffuseur opale satiné partie haute



600-340-xx
Support suspension inclus
câble de suspension 3,00m

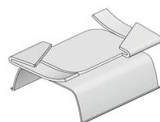

600-340-03
fixation pour plafond
dalles suspendu



600-340-xx
Fixation pour fixation en sailli

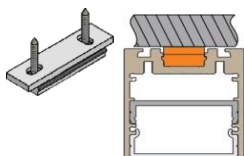

550-575-86 / 261-506-99
Kit de fixation magnétique HR



550-490-86
kit de fixation



550-875-86
Kit de fixation magnétique

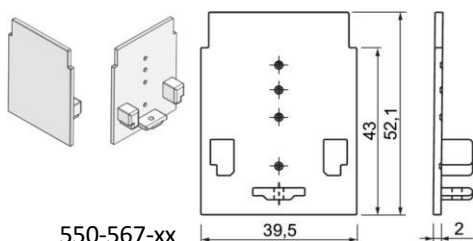

550-567-xx
Embouts de finition Epic III

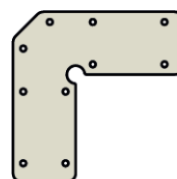

550-564-92
Raccordement d'angle

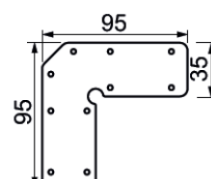

550-565-92
Raccordement droit intérieur

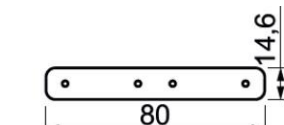

550-576-92
raccordement droit partie haute

Alimentation DALI Dimmable



552-650-01 Dimension 346 x 32 x 22 200-240Vac/24Vdc 50W
552-650-01 Dimension 346 x 32 x 22 200-240Vac/24Vdc 80W

Alimentation non Dimmable



552-617-50 Dimension 251 x 30 x 17 200-240Vac/24Vdc 30W
552-610-50 Dimension 346 x 30 x 16 200-240Vac/24Vdc 45W
552-603-50 Dimension 305 x 30 x 16,7 200-240Vac/24Vdc 75W
552-618-50 Dimension 320 x 30 x 19,5 200-240Vac/24Vdc 100W

= 1 longueur de 1,00 m | # = 2 longueur de 2,01 m | # = 3 longueur de 3,02 m

*Frais de transport à prévoir pour longueur supérieure à 2,01 m

Toutes les informations, les images et les fichiers sur cette page sont données à titre indicatif et peuvent subir des modifications sans préavis

P4043-4 Profil EPIC IV

Puissance maximum 48W/m



Référence	Désignation
500-561-0#000	Profile aluminum EPIC, anodisé
500-561-1#000	Profile aluminum EPIC, blanc RAL 9010
500-561-2#000	Profile aluminum EPIC, noir RAL 9005
500-561-3#000	Profile aluminum EPIC, autre RAL sur demande

Profil Epic Light support LED

Référence	Désignation
500-562-0#000	Profile aluminum, anodisé
500-562-1#000	Profile aluminum, blanc RAL 9010
500-562-2#000	Profile aluminum, noir RAL 9005
500-562-3#000	Profile aluminum, autre RAL sur demande

Diffuseur

Référence	Désignation
501-563-5#	Diffuseur bas blanc opale 67%
501-372-5#	Diffuseur haut blanc opale 62%
501-563-8#	Diffuseur bas noir opale

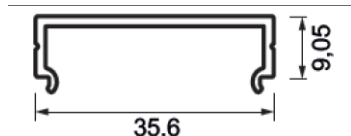
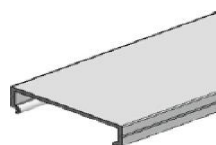
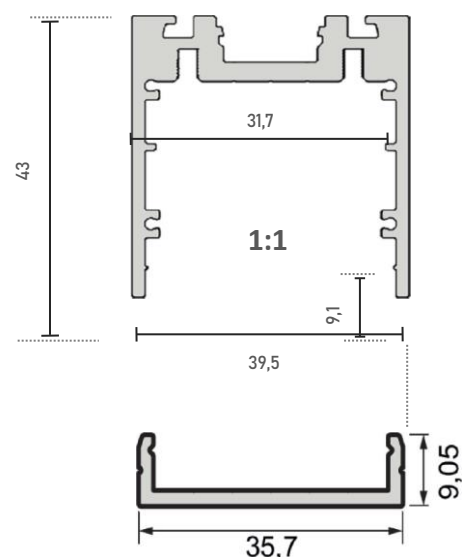
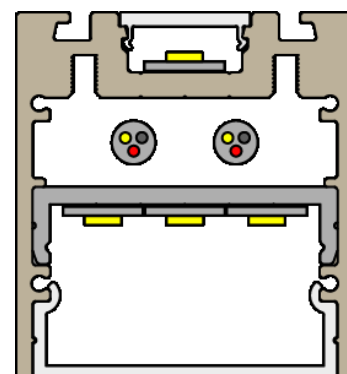

501-563-5#000
Diffuseur PMMA, opale

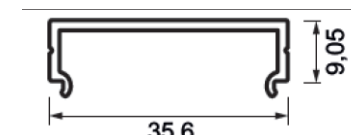

501-563-8#000
Diffuseur PMMA, opale Noir

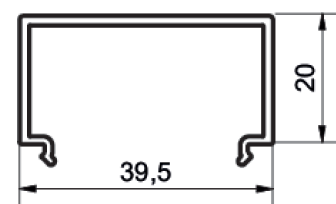
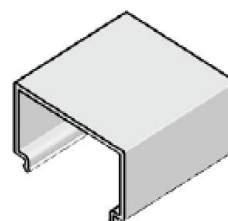

501-572-5#000
Diffuseur haut, PMMA, opale



= 1 longueur de 1,00 m | # = 2 longueur de 2,01 m | # = 3 longueur de 3,02 m

*Frais de transport à prévoir pour longueur supérieure à 2,01 m

Toutes les informations, les images et les fichiers sur cette page sont données à titre indicatif et peuvent subir des modifications sans préavis

ACCESSOIRES EPIC IV



501-841-5#000
Diffuseur cristallisé partie haute



501-841-1#000
Diffuseur transparent partie haute



501-841-8#000
Diffuseur opale satiné partie haute



600-340-xx
Support suspension inclus
câble de suspension 3,00m

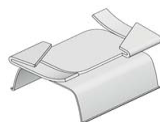

600-340-03
fixation pour plafond
dalles suspendu



600-340-xx
Fixation pour fixation en sailli

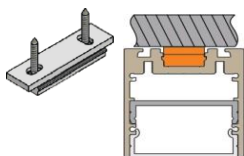

550-575-86 / 261-506-99
Kit de fixation magnétique HR



550-490-86
kit de fixation



550-875-86
Kit de fixation magnétique

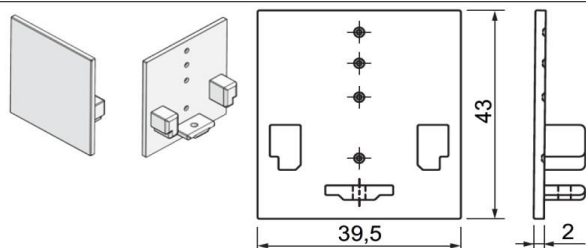

550-566-xx

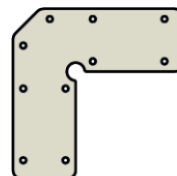

550-564-92
Raccordement d'angle

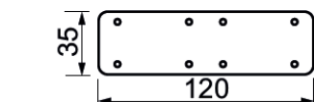
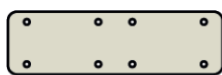
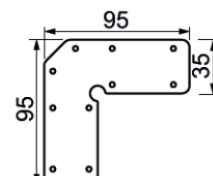

550-565-92
Raccordement droit intérieur

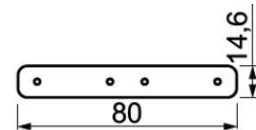

550-576-92
raccordement droit partie haute

Alimentation DALI Dimmable



552-650-01 Dimension 346 x 32 x 22 200-240Vac/24Vdc 50W
552-650-01 Dimension 346 x 32 x 22 200-240Vac/24Vdc 80W

Alimentation non Dimmable



552-617-50 Dimension 251 x 30 x 17 200-240Vac/24Vdc 30W
552-610-50 Dimension 346 x 30 x 16 200-240Vac/24Vdc 45W
552-603-50 Dimension 305 x 30 x 16,7 200-240Vac/24Vdc 75W
552-618-50 Dimension 320 x 30 x 19,5 200-240Vac/24Vdc 100W

= 1 longueur de 1,00 m | # = 2 longueur de 2,01 m | # = 3 longueur de 3,02 m

*Frais de transport à prévoir pour longueur supérieure à 2,01 m

Toutes les informations, les images et les fichiers sur cette page sont données à titre indicatif et peuvent subir des modifications sans préavis

P1136-7 Profil EPIC-VII

Puissance maximum 48W/m



Référence	Désignation
500-569-0#	Profilé aluminium ULTIMATE, anodisé
500-569-1#	Profilé aluminium ULTIMATE, blanc
500-569-2#	Profilé aluminium ULTIMATE, noir
500-569-3#	Profilé aluminium ULTIMATE, autre RAL sur demande

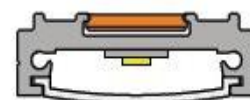

550-569-xx
Profilé support LED

Profile Ultimate support LED

Référence	Désignation
500-569-0#	Profile aluminum, anodisé
500-569-1#	Profile aluminum, blanc RAL 9010
500-569-2#	Profile aluminum, noir RAL 9005
500-569-3#	Profile aluminum, autre RAL sur demande

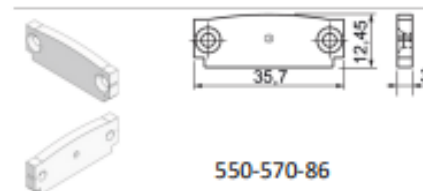

550-570-86

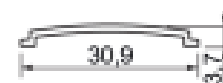

501-83x-0x00

Diffuseurs

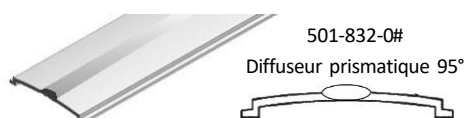
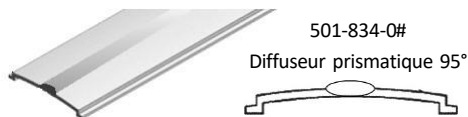
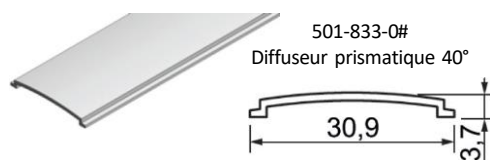

Accessoires

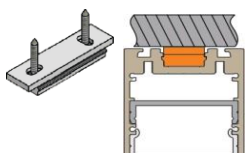

550-575-86 / 261-506-99
Kit de fixation magnétique HR



550-490-86
kit de fixation



550-875-86
Kit de fixation magnétique

= 1 longueur de 1,00 m | # = 2 longueur de 2,01 m | # = 3 longueur de 3,02 m
*Frais de transport à prévoir pour longueur supérieur à 2,01 m

Toutes les informations, les images et les fichiers sur cette page sont données à titre indicatif et peuvent subir des modifications sans préavis

ACCESSOIRES EPIC VII



501-841-5#000
Diffuseur cristallisé partie haute



501-841-1#000
Diffuseur transparent partie haute



501-841-8#000
Diffuseur opale satiné partie haute



600-340-xx
Support suspension inclus
câble de suspension 3,00m

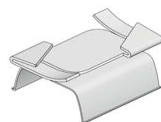

600-340-03
fixation pour plafond
dalles suspendu



600-340-xx
Fixation pour fixation en sailli

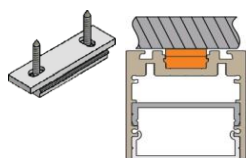

550-575-86 / 261-506-99
Kit de fixation magnétique HR



550-490-86
kit de fixation



550-875-86
Kit de fixation magnétique

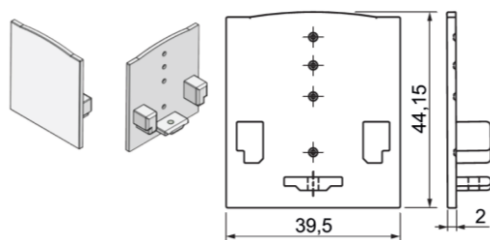

550-568-xx
Embout de finition Epic I

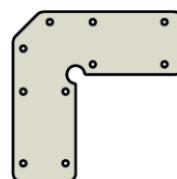

550-564-92
Raccordement d'angle

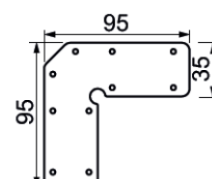

550-565-92
Raccordement droit intérieur

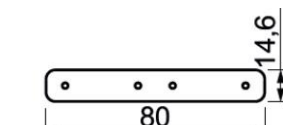

550-576-92
raccordement droit partie haute

Alimentation DALI Dimmable



552-650-01 Dimension 346 x 32 x 22 200-240Vac/24Vdc 50W
552-650-01 Dimension 346 x 32 x 22 200-240Vac/24Vdc 80W

Alimentation non Dimmable



552-617-50 Dimension 251 x 30 x 17 200-240Vac/24Vdc 30W
552-610-50 Dimension 346 x 30 x 16 200-240Vac/24Vdc 45W
552-603-50 Dimension 305 x 30 x 16,7 200-240Vac/24Vdc 75W
552-618-50 Dimension 320 x 30 x 19,5 200-240Vac/24Vdc 100W

= 1 longueur de 1,00 m | # = 2 longueur de 2,01 m | # = 3 longueur de 3,02 m

*Frais de transport à prévoir pour longueur supérieure à 2,01 m

Toutes les informations, les images et les fichiers sur cette page sont données à titre indicatif et peuvent subir des modifications sans préavis

P4043-6 Profil EPIC-VI

Puissance maximum 48W/m



Référence	Désignation
500-561-0#	Profile aluminum EPIC, anodisé
500-561-1#	Profile aluminum EPIC, blanc RAL 9010
500-561-2#	Profile aluminum EPIC, noir RAL 9005
500-561-3#	Profile aluminum EPIC, autre RAL sur demande

Profil Epic Light support LED

Référence	Désignation
500-562-0#	Profile aluminum, anodisé
500-562-1#	Profile aluminum, blanc RAL 9010
500-562-2#	Profile aluminum, noir RAL 9005
500-562-3#	Profile aluminum, autre RAL sur demande

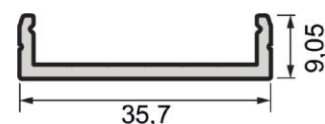
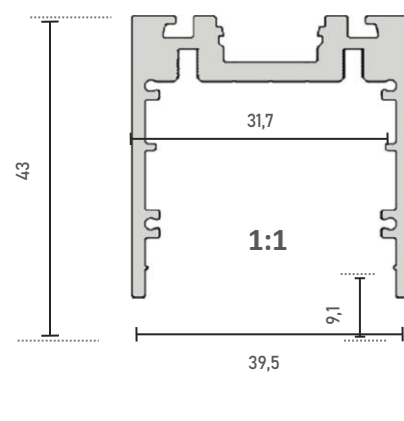
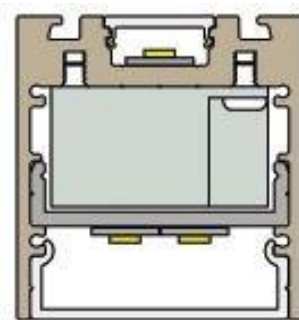

= 1 longueur de 1,00 m | # = 2 longueur de 2,01 m | # = 3 longueur de 3,02 m

*Frais de transport à prévoir pour longueur supérieur à 2,01 m

Toutes les informations, les images et les fichiers sur cette page sont données à titre indicatif et peuvent subir des modifications sans préavis

ACCESSOIRES EPIC VI



501-841-5#000
Diffuseur cristallisé partie haute



501-841-1#000
Diffuseur transparent partie haute



501-841-8#000
Diffuseur opale satiné partie haute



600-340-xx
Support suspension inclus
câble de suspension 3,00m

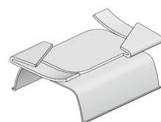

600-340-03
fixation pour plafond
dalles suspendu



600-340-xx
Fixation pour fixation en sailli

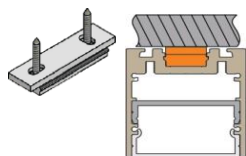

550-575-86 / 261-506-99
Kit de fixation magnétique HR



550-490-86
kit de fixation



550-875-86
Kit de fixation magnétique

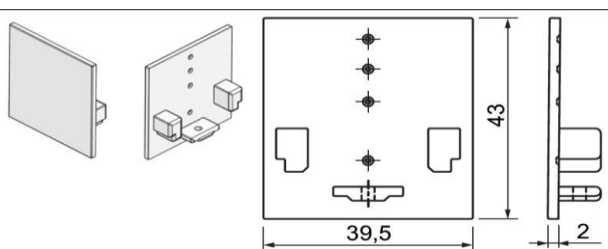

550-566-xx EPIC VI

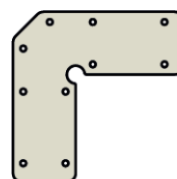

550-564-92
Raccordement d'angle

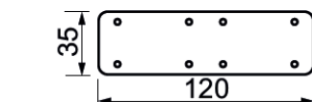
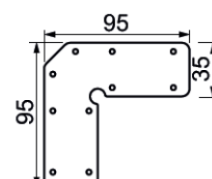

550-565-92
Raccordement droit intérieur

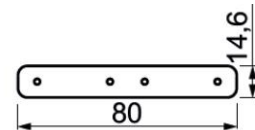

550-576-92
raccordement droit partie haute

Alimentation DALI Dimmable



552-650-01 Dimension 346 x 32 x 22 200-240Vac/24Vdc 50W
552-650-01 Dimension 346 x 32 x 22 200-240Vac/24Vdc 80W

Alimentation non Dimmable



552-617-50 Dimension 251 x 30 x 17 200-240Vac/24Vdc 30W
552-610-50 Dimension 346 x 30 x 16 200-240Vac/24Vdc 45W
552-603-50 Dimension 305 x 30 x 16,7 200-240Vac/24Vdc 75W
552-618-50 Dimension 320 x 30 x 19,5 200-240Vac/24Vdc 100W

= 1 longueur de 1,00 m | # = 2 longueur de 2,01 m | # = 3 longueur de 3,02 m

*Frais de transport à prévoir pour longueur supérieure à 2,01 m

P4043-10 Profil EPIC X

Puissance maximum 48W/m



Référence	Désignation
500-561-0#000	Profile aluminum EPIC, anodisé
500-561-1#000	Profile aluminum EPIC, blanc RAL 9010
500-561-2#000	Profile aluminum EPIC, noir RAL 9005
500-561-3#000	Profile aluminum EPIC, autre RAL sur demande

Profil Epic Light support LED

Référence	Désignation
500-562-0#000	Profile aluminum, anodisé
500-562-1#000	Profile aluminum, blanc RAL 9010
500-562-2#000	Profile aluminum, noir RAL 9005
500-562-3#000	Profile aluminum, autre RAL sur demande

Epic Focus 2700, 3000, 4000K 700mA

Référence	Désignation
578-913-XXXX	10,4W, 5, 12°, >80, 840 à 960 Lm, 138,8x35,7x28,5
578-914-XXXX	20,8W, 10, 12°, >80, 2700, 1680 à 1920 Lm, 270,8x35,7x28,5
578-915-XXXX	31,2W, 15, 12°, >80, 2700K, 2520 à 2880Lm, 402,8x35,7x28,5,

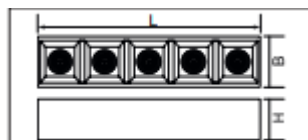
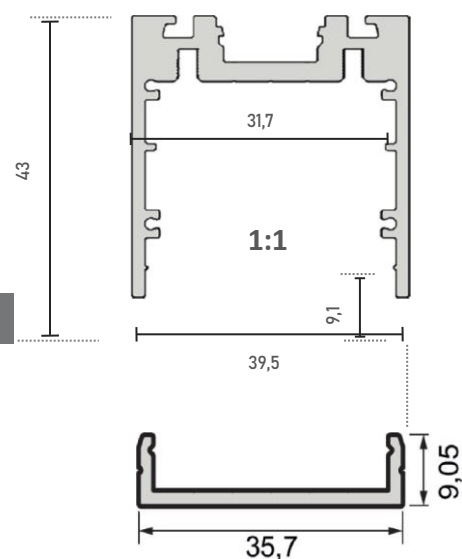
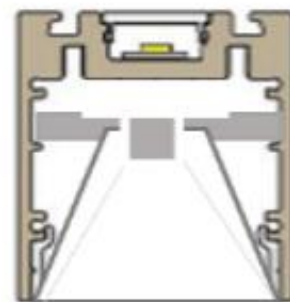

= 1 longueur de 1,00 m | # = 2 longueur de 2,01 m | # = 3 longueur de 3,02 m

*Frais de transport à prévoir pour longueur supérieure à 2,01 m

Toutes les informations, les images et les fichiers sur cette page sont données à titre indicatif et peuvent subir des modifications sans préavis

ACCESSOIRES EPIC 10



501-841-5#000
Diffuseur cristallisé partie haute



501-841-1#000
Diffuseur transparent partie haute



501-841-8#000
Diffuseur opale satiné partie haute



600-340-xx
Support suspension inclus
câble de suspension 3,00m

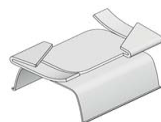

600-340-03
fixation pour plafond
dalles suspendu



600-340-xx
Fixation pour fixation en sailli

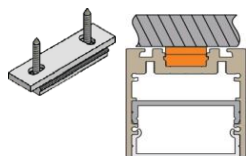

550-575-86 / 261-506-99
Kit de fixation magnétique HR



550-490-86
kit de fixation



550-875-86
Kit de fixation magnétique

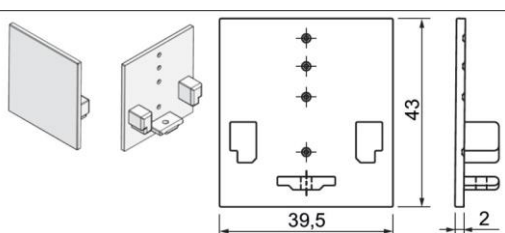

550-566-xx

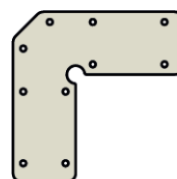

550-564-92
Raccordement d'angle

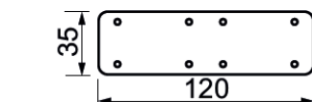
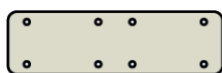
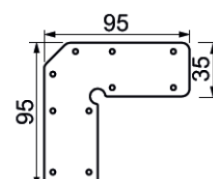

550-565-92
Raccordement droit intérieur

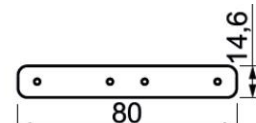

550-576-92
raccordement droit partie haute

Alimentation DALI Dimmable



552-650-01 Dimension 346 x 32 x 22 200-240Vac/24Vdc 50W
552-650-01 Dimension 346 x 32 x 22 200-240Vac/24Vdc 80W

Alimentation non Dimmable



552-617-50 Dimension 251 x 30 x 17 200-240Vac/24Vdc 30W
552-610-50 Dimension 346 x 30 x 16 200-240Vac/24Vdc 45W
552-603-50 Dimension 305 x 30 x 16,7 200-240Vac/24Vdc 75W
552-618-50 Dimension 320 x 30 x 19,5 200-240Vac/24Vdc 100W

ACCESSOIRES EPIC



600-340-xx
Support suspension inclus
câble de suspension 3,00m



600-340-03
fixation pour plafond
dalles suspendu

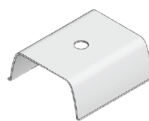

600-340-xx
Fixation en saillis

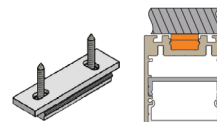

550-575-86 / 261-506-99
Fixation magnétique



550-490-86
kit de fixation



550-875-86
Kit de fixation magnétique

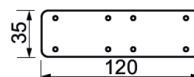

550-565-92
Raccordement droit intérieur

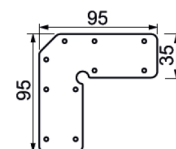

550-564-92
Raccordement d'angle

EMBOUS DE FINITION

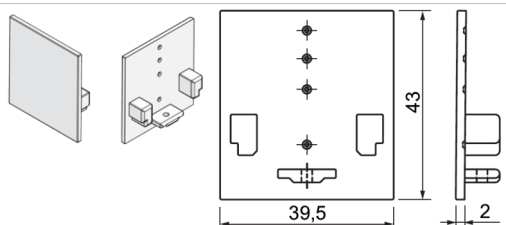

550-566-xx
Embout de finition Epic II, IV, V et VI

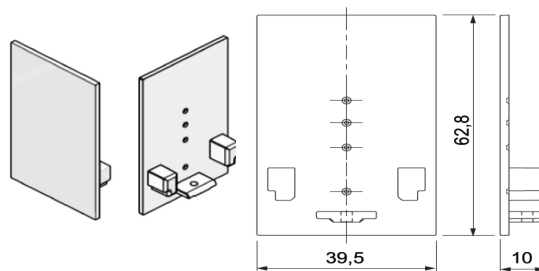

550-573-xx
Embout de finition Epic VIII

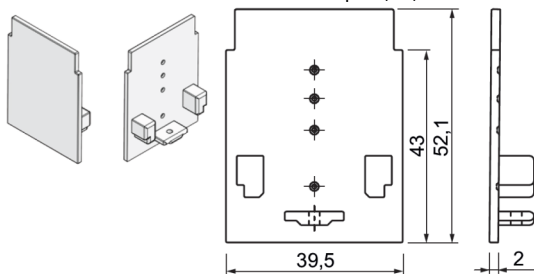

550-567-xx
Embout de finition Epic III

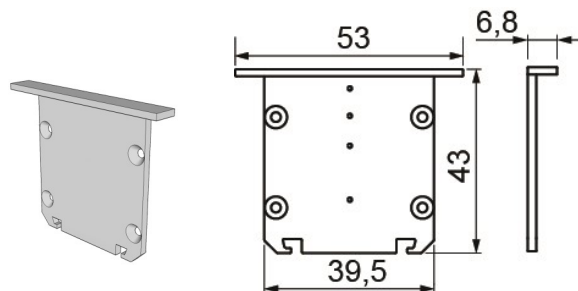

550-585-xx
Embout de finition Epic WING

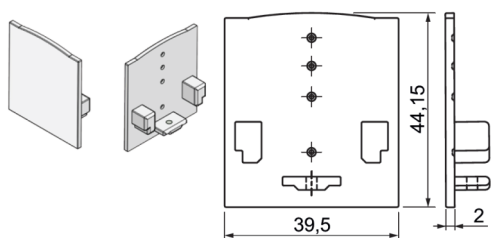

550-568-xx
Embout de finition Epic I

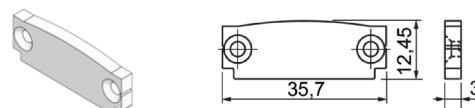

550-570-yy
Embout de finition Epic VII

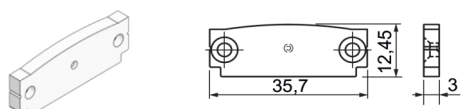

550-571-yy
Embout de finition Epic VII
avec passage câble